

— USER MANUAL
P5R CORE
P5R WORK



 LEDLENSER

Many Thanks

We are pleased that you have chosen a product from our company. To familiarize yourself with your new product, you will find information for safety and operation in these operating instructions.

These instructions for use must be read carefully before using the product. It must be kept and handed over to third parties when the product is passed on.

This also serves to ensure that you get the maximum benefit from your product, get answers to your questions and avoid operating errors. Therefore, pay particular attention to the warning and safety instructions and properly dispose of the lamp, batteries and packaging material.

P5R Core



P5R Work



Table of contents

1. Scope of delivery
2. Warning
3. Magnetic Charging System
4. Battery Replacement
5. Default Operation
6. Boost Function
7. Advanced Focus System
8. Backup Mode
9. Customizing Light Modes
10. Additional Functions
11. Reset to Factory Settings
12. Further Information

General product information

The Ledlenser P5R Core and P5R Work are flashlights and may only be used as such for lighting purposes. Use the products only at ambient temperatures of -20°C to $+40^{\circ}\text{C}$. The flashlights do not be used in areas with a potentially explosive atmosphere. The flashlights are no toys and are not suitable for small children.

Please register your product with the enclosed registration card to obtain an extended warranty, check the authenticity of the product and receive updates about products or product improvements.



① Scope of delivery

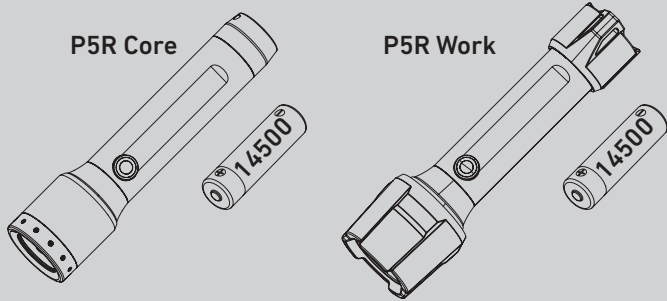

1. The flashlight is delivered with the scope of delivery shown. The product may only be used with the following rechargeable batteries:

P5R Core: 14500 Li-ion, 3.7V (Item No. 500985)

P5R Work: 14500 Li-ion, 3.7V (Item No. 500985)

Rechargeable batteries may only be charged at temperatures from 10°C to 40°C.

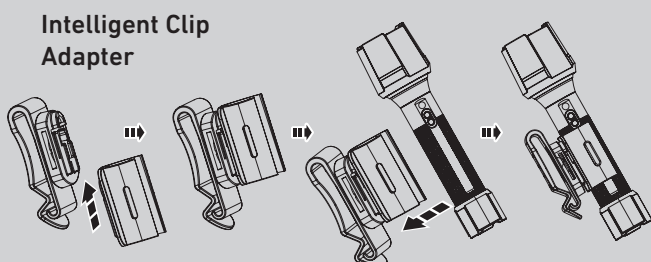
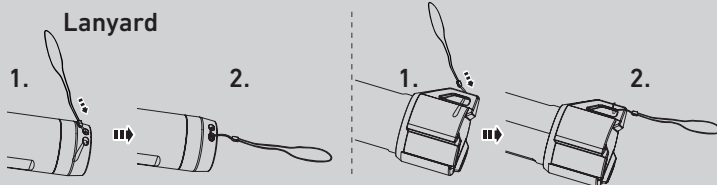
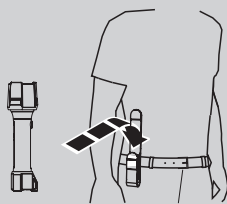
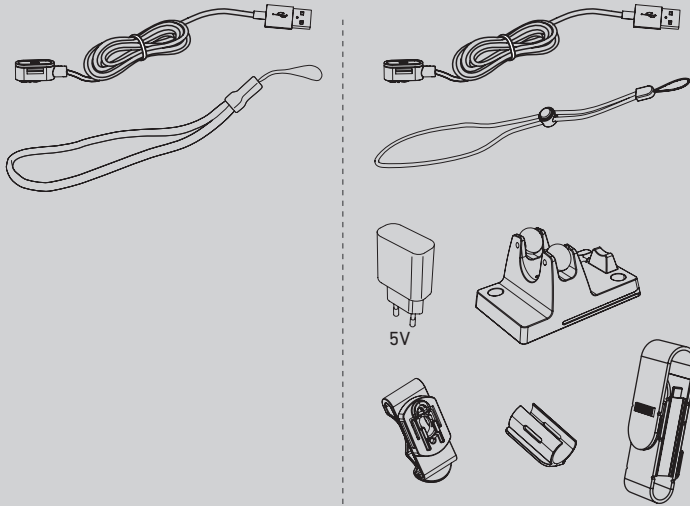

② WARNING

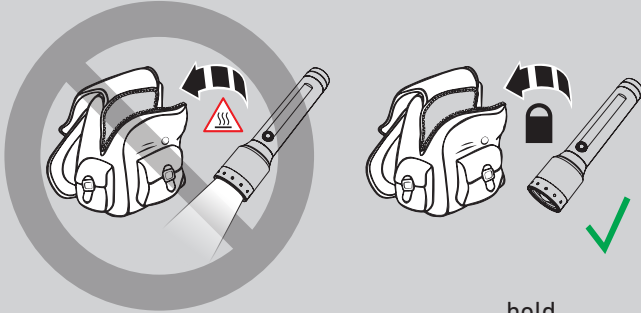
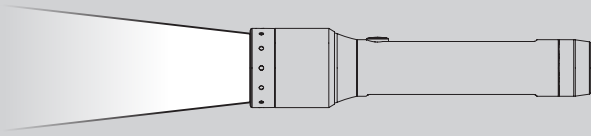

Transportation Lock

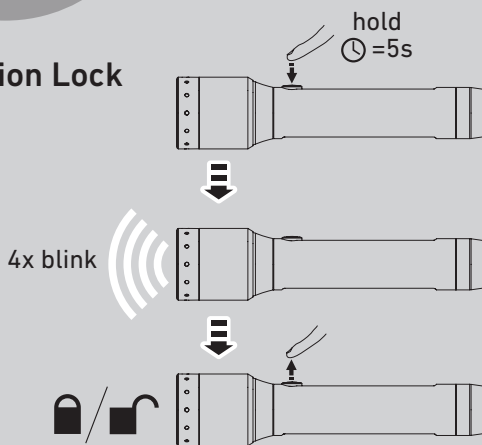

- 2. CAUTION:** The lamp generates heat when in use. Do not cover the lamp during operation, this can lead to heat build-up. Maintain a distance of at least 10 cm between the lamp and illuminated surfaces.

Make sure that the lamp is locked during transport and cannot be switched on accidentally.

③ Magnetic Charging System

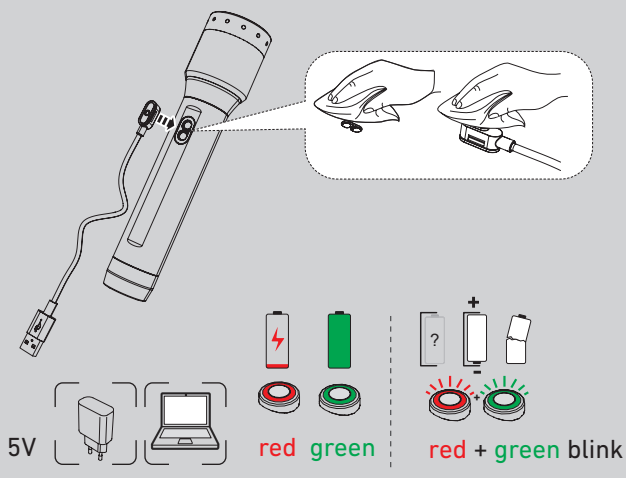

- 3.** The included USB magnetic charging cable is used for charging. If the contacts on the lamp or cable are dirty or dusty, first clean them with a dry cloth. Then connect the cable to the lamp, paying attention to the correct orientation of the contacts. Finally, connect the charging cable to a standard USB power supply or computer.

While the lamp is charging, the charge level indicator lights up red. When the charging process is complete, the display changes to green. If an error occurs, the charge indicator flashes (e.g. defective or incorrectly inserted battery).

Rechargeable batteries may only be charged at temperatures of 10°C to 40°C. Optionally, the batteries can be removed from the lamp and charged externally with a suitable charger.

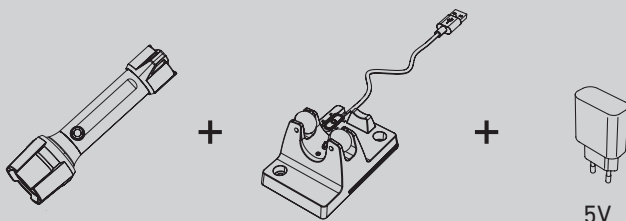

4 Battery Replacement

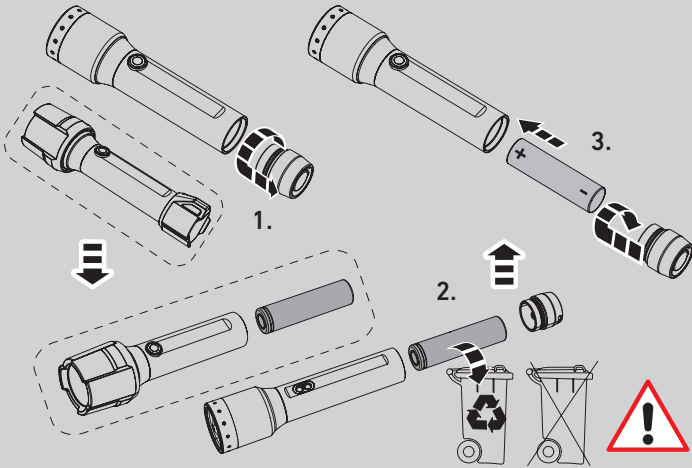

- To remove the rechargeable battery, the end cap of the lamp is screwed off. The battery can then be removed. When inserting a new battery, pay attention to the correct polarity (+/-). This is marked on the battery and inside the lamp shaft. Only approved batteries may be used. Then close the lamp again by screwing the end cap on. To ensure watertightness, make sure that the seals are undamaged.

5 Default Operation

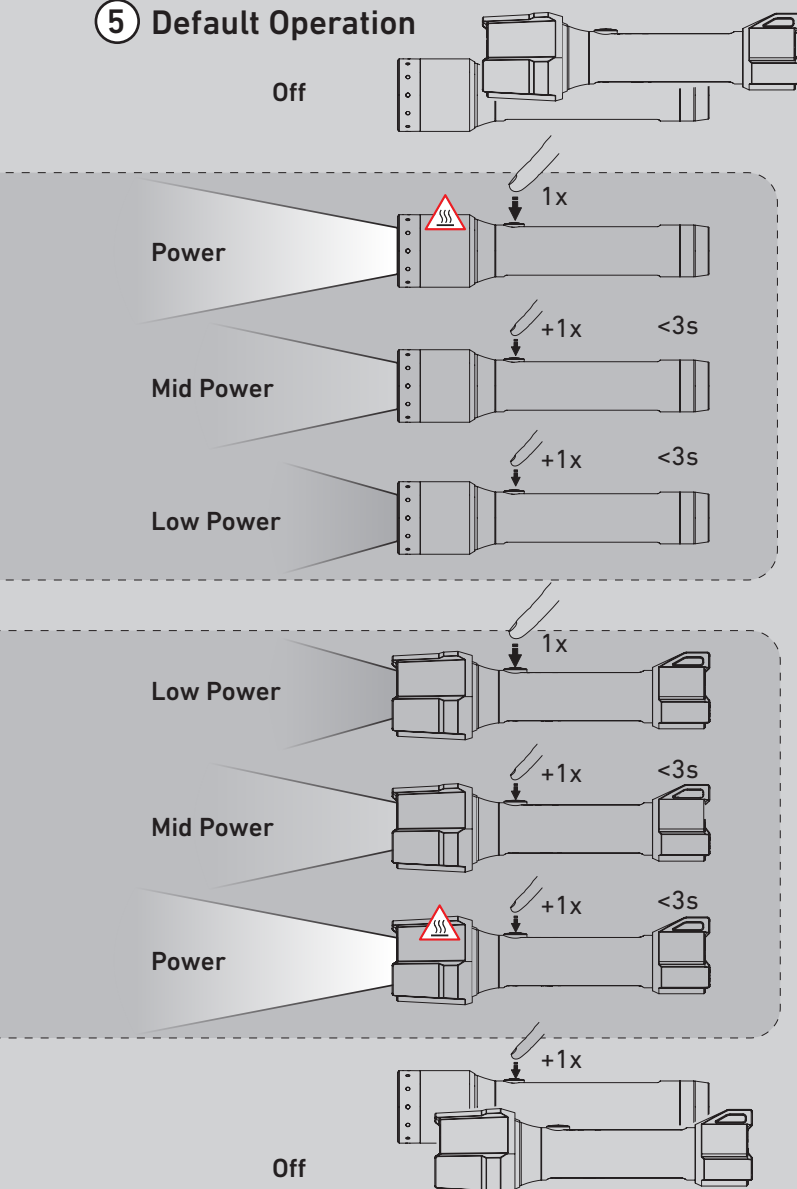

- This lamp has several light functions or brightness levels.

The desired function can be selected within the first three seconds after switching the lamp on. To do this, first switch the lamp on and then tap the switch once within three seconds to switch to the next function.

If the switch has not been pressed for more than three seconds or if the last available light function has been selected, the lamp switches off the next time the switch is pressed.

When the lamp is switched on, the remaining battery capacity is displayed (**GREEN** fully charged; **ORANGE** half full; **RED** almost empty)

If the „Memory Mode“ is active, the lamp always turns on with the previously selected light function. If the „Memory Mode“ is deactivated, the lamp always starts with the same light function. The „Memory Mode“ can be activated and deactivated in the advanced settings (10).

6 Boost Function

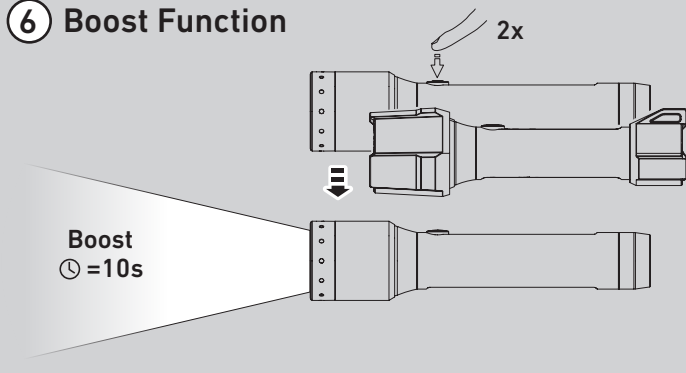

6. In boost mode, the lamp lights up with the maximum available brightness for a period of ten seconds. The boost mode can be activated at any time by double tapping the switch, except when the transportation lock is activated. After ten seconds the lamp switches back to the previously selected light function.

7 Advanced Focus System

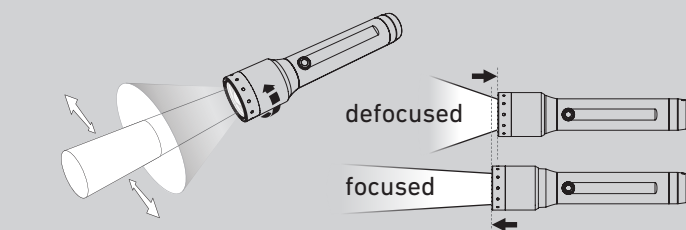

7. Different activities require different light. By turning the lamp head whilst moving it forwards or backwards, the light can be focused for maximum beam distance or defocused for even illumination of the close-up area.

8 Backup Mode

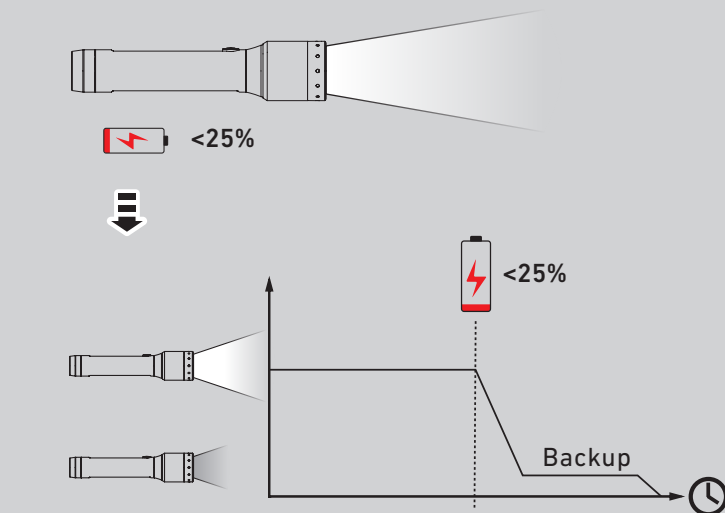

8. If the remaining battery capacity is low - after the regular runtime has expired - the lamp switches to „Backup Mode“. In this mode the lamp can only be used in the lowest brightness level. It prevents the lamp from suddenly switching off and ensures that the user still has light available when the battery is weak.

The „Backup Mode“ can be activated or deactivated in the advanced settings. If the backup mode is deactivated, the lamp is operated at full brightness until the end of the battery capacity and then switches off immediately.

When the „Low Battery Warning“ is active, which can be activated or deactivated in the advanced settings, the lamp gives a flashing signal every 15 minutes when the battery capacity is low.

9 Customizing Light Modes

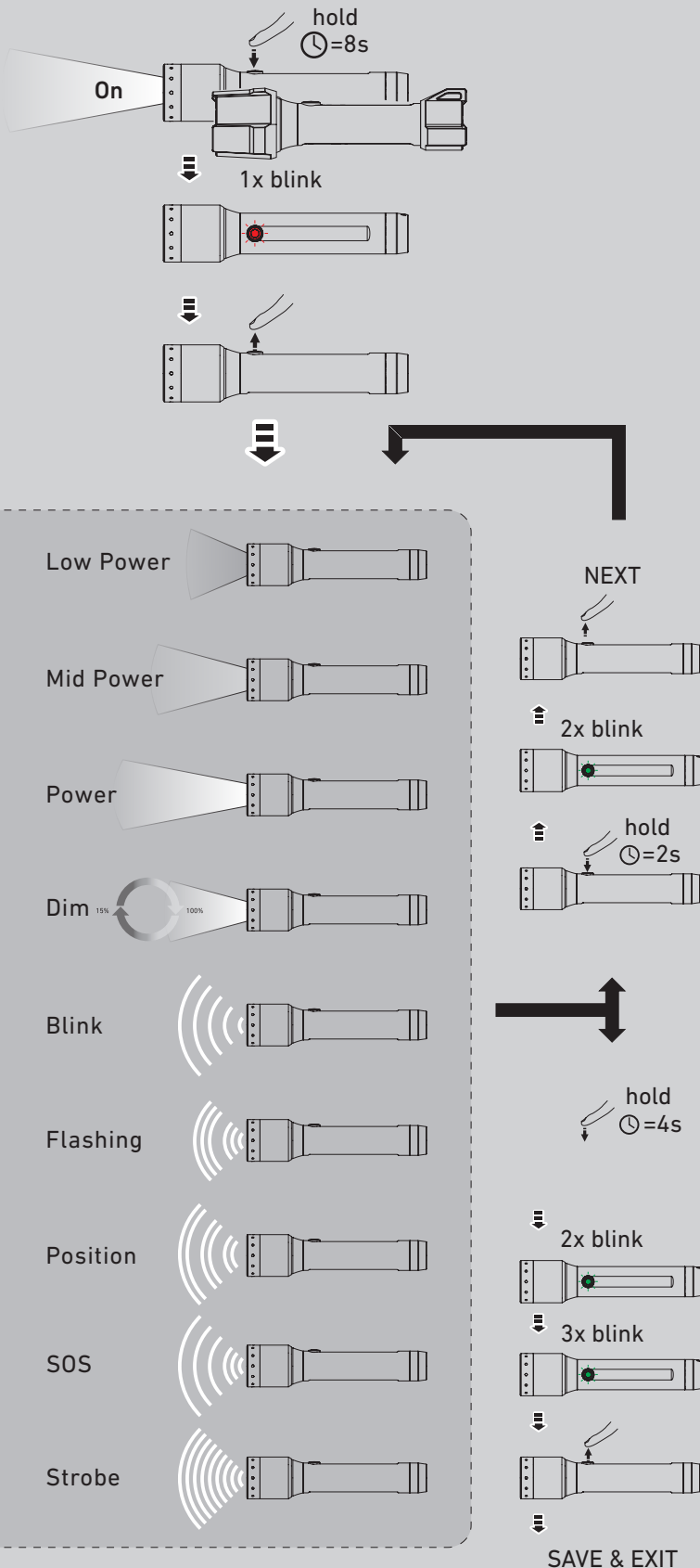

9. The flashlight is preset with selected light functions and brightness levels. If desired, the default settings can be changed via the switch on the lamp. Proceed as follows:

- Hold down the switch for five seconds while the light is on. Do not cover the switch completely, in order to still be able to see the indicator light inside the switch.
- After five seconds the switch will flash briefly. Release the switch immediately.
- By briefly pressing the switch, you can switch through all available light functions and brightness levels.

- If you want to save the selected light function, hold the switch down for two seconds. The switch will flash twice to confirm. You can repeat this process up to a total of ten times in order to save further light functions.

- Alternatively, press and hold the switch for four seconds to save the selected light function(s) and to end the process (after the switch has flashed three times).

- The lamp has now been programmed with the selected light functions. These can now be activated in the selected order by tapping the switch several times within three seconds after switching the lamp on.

⑩ Additional Functions

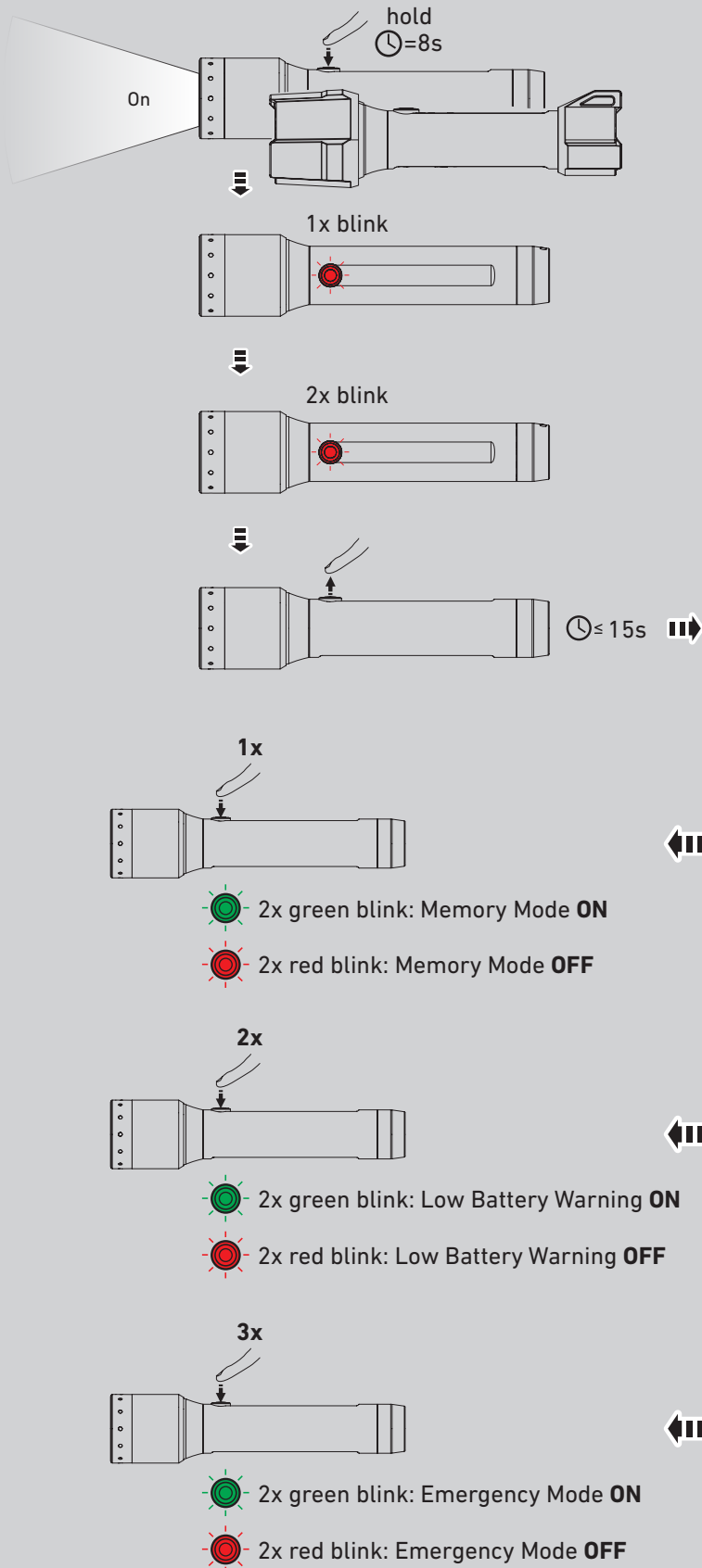

10. You can use the advanced settings to switch additional functions on or off. To do this, switch on the lamp. Hold down the switch for about eight seconds. The switch flashes once, then twice. Release the switch when it has blinked twice.

Now tap the switch briefly several times to activate or deactivate functions. If you want to activate or deactivate another function, start the process again from the beginning (10.).

With a single tap, the **Memory Mode** is switched on or off (see also No. 5).

If you tap it twice, the **Low Battery Warning** is switched on or off (see also No. 8).

If you tap it three times, the **Emergency Mode** is switched on or off. When the emergency mode is active, the lamp is switched on automatically if it is disconnected from the power supply while charging. This means that the lamp comes on automatically in the event of a power failure or is immediately active when it is removed from the holder.

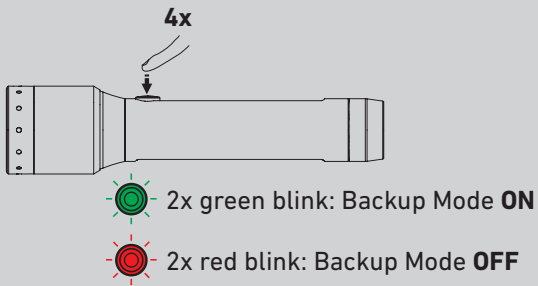

If you tap the switch four times, the **Backup Mode** is switched on or off (see also No. 8).

11 Reset to factory settings

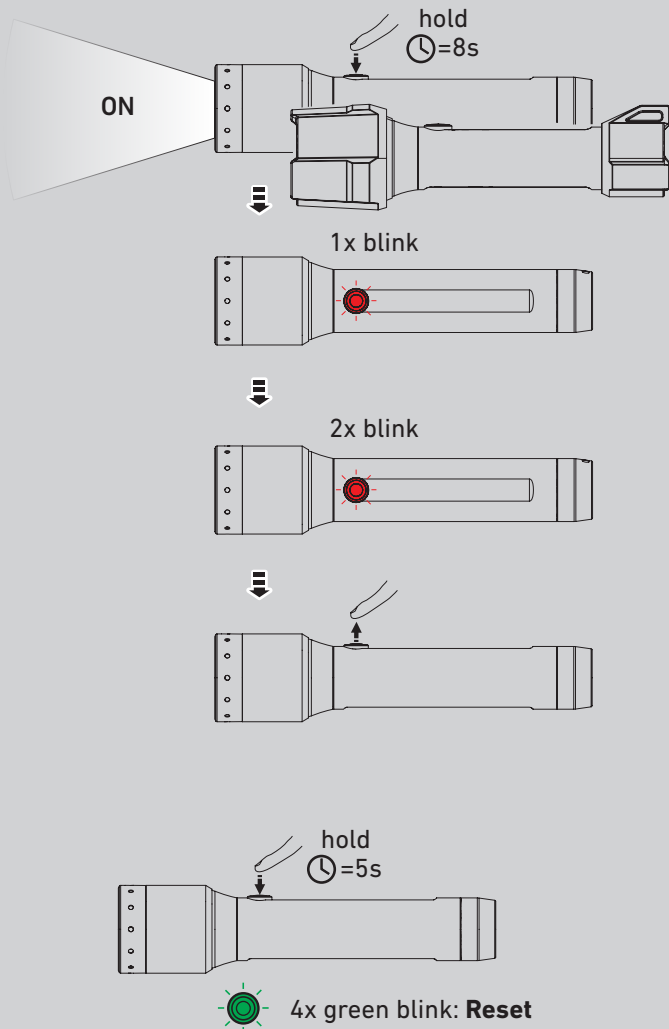

11. The lamp can be reset to factory settings. To do this, switch on the lamp. Hold down the switch for about eight seconds. The switch flashes once, then twice. Release the switch when it has blinked twice.

Then press the switch again for five seconds until it flashes four times. Now release the switch. The lamp has been reset to the factory settings and can be used again as usual.

12 Further Information

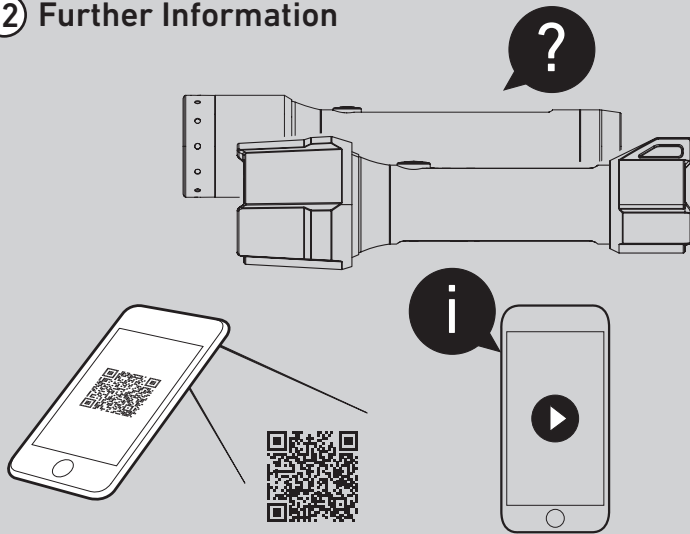

12. Further information, tutorials and accessories can be found on our website. Simply scan the QR code or visit www.ledlenser.com.

P5R Core



P5R Work

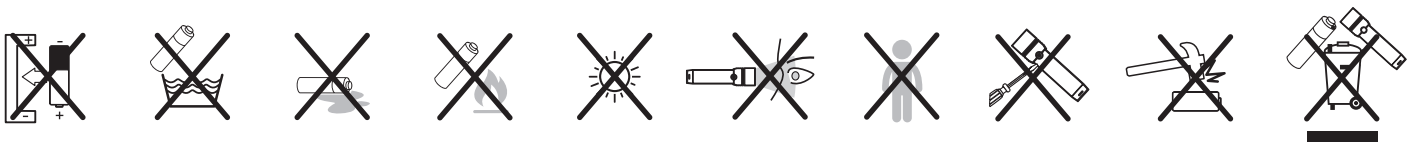

ledlenser.com

Ledlenser GmbH & Co. KG

Kronenstr. 5-7, 42699 Solingen

Phone +49 212/5948-0 Fax +49 212/5948-200

info@ledlenser.com